

# Pushbutton

## Type M-10 RET, REB, RST & RSB

Publication Number PB187/0208

### Application

The M-10 pushbutton is ideal for use in all types of lift, especially in office, retail and apartment applications. The button legend and wide halo illumination provides a bright, wide-angle view in all lighting conditions, ensuring clear identification on call acceptance. The M-10 is available in a range of colours.

The M-10 has a number of features to ensure easy installation, thus reducing any on-costs. These include screw-in connectors and front mounting, so there is no need for studs.

Variants of the M-10 are designed to meet EN81-70, EN81-71, B-44 and AS1735 part 12.

### Operation

Operation of the spring return pressel makes contact with the microswitch. The pressel will bottom out on the halo moulding, protecting the microswitch from abuse. On call acceptance the legend and halo is illuminated with the same colour until the call has been cancelled. Standard illumination is through long life LEDs at 6V, 12V or 24V.

### Installation

The pressel body assembly with surround is mounted from the front and secured in place by the nut provided. The illumination/switch body is then clipped to the pressel assembly body and installation is complete. Wiring of the product is direct to the illumination/switch body, which has screw connectors.

M-10 button can be supplied complete in stations or loose. The button is designed to be fitted in a faceplate of thickness between 1.5mm and 3.0mm with a vertical pitch of 50mm and horizontal pitch of 50mm.

### Technical Details

Weight	37 grams (approximate)
Moulded in	High Grade Polycarbonate (Flame retardant)
Environmental Protection	IP54
Pressel Plate Material	Stainless, Braille, Coloured Anodised Aluminium (black, green, yellow)
LED current	20 mA (typically)
LED colours	choose from: red; green; white; yellow; blue
LED voltage	6V, 12V or 24V

Designed to meet the requirements of BS CECC 90400: Pushbutton Switches where relevant, EN81-1/2, EN81-70 and EN81-71 (category 1 vandal resistance)

### Ratings

Electrical rating of Cherry microswitch:	125V a.c. at 3.0 amps max 30V d.c. at 2.0 amps max
Mechanical life:	1,000,000 operations min.
Electrical life of M-20 Pushbutton:	1,000,000 operations min.
Contact arrangements:	Single microswitch – changeover 1 C/O Twin microswitch – 2 N/O, 1N/O + 1 N/C, 2 N/C

**Dewhurst plc** t +44 (0)20 8607 7300 f +44 (0)20 8572 5986 info@dewhurst.co.uk www.dewhurst.co.uk  
Contact your local sales office:

<b>Australia</b>	<b>D</b> Australian lift components	t 02 9603 0200	f 02 9603 2700	info@alc.au.com	www.alc.au.com
	<b>D</b> lift material	t 02 9310 4288	f 02 9698 4990	info@liftmaterial.com	www.liftmaterial.com
<b>Canada</b>	<b>D</b> dupar controls	t 519 624 2510	f 519 624 2524	info@dupar.com	www.dupar.com
<b>UK</b>	<b>D</b> LiftStore	t 020 8538 1770	f 020 8538 1771	info@liftstore.com	www.liftstore.com
<b>USA</b>	<b>D</b> the fixture company	t 847 214 3100	f 847 214 2771	info@thefixtureco.com	www.thefixtureco.com

M-10  
TYPE RET

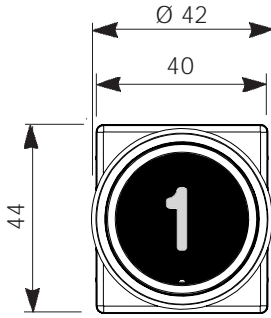

Round En  
Tactile

M-10  
TYPE REB

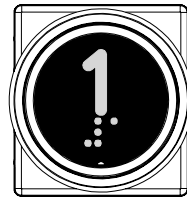

Round En  
Braille

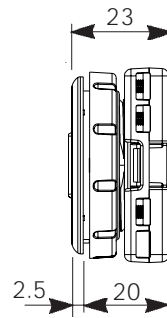

M-10  
TYPE RST

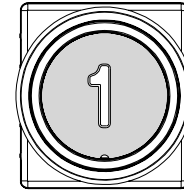

Round Stainless  
Steel Tactile

M-10  
TYPE RSB

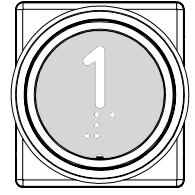

Round Stainless  
Steel Braille

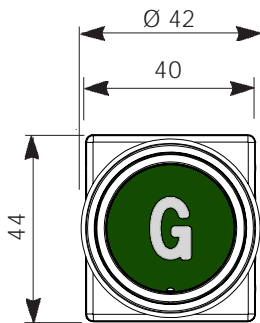

EN Exit Floor

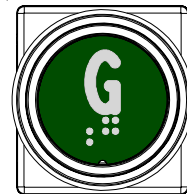

EN Braille Exit  
Floor

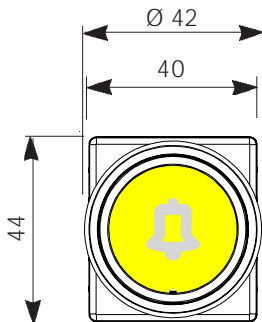
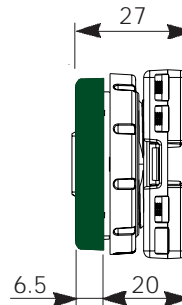

EN Alarm

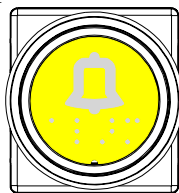

EN Braille  
Alarm

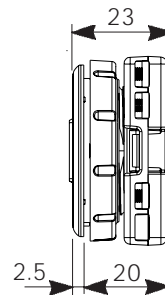

M10 Pushbutton  
Cutout Dimensions

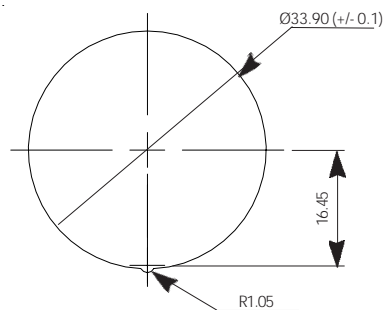

Dewhurst plc t +44 (0)20 8607 7300 f +44 (0)20 8572 5986  
Contact your local sales office:

info@dewhurst.co.uk www.dewhurst.co.uk

**Australia** D Australian lift components

t 02 9603 0200

f 02 9603 2700

info@alc.au.com

www.alc.au.com

D lift material

t 02 9310 4288

f 02 9698 4990

info@liftmaterial.com

www.liftmaterial.com

**Canada** D dupar controls

t 519 624 2510

f 519 624 2524

info@dupar.com

www.dupar.com

**UK** D LiftStore

t 020 8538 1770

f 020 8538 1771

info@liftstore.com

www.liftstore.com

**USA** D the fixture company

t 847 214 3100

f 847 214 2771

info@thefixtureco.com

www.thefixtureco.com